

Typical Performance Technical Data Sheet



Catalog No S2XLH21-37

Characteristics	
Phase	1
KVA	37
Primary	240x480v
Secondary	120/240v
Conductor	Aluminum
Temp. Rise	150° C
Frequency	60 HZ
Taps	+2, -4 x 2.5%
ESS	No
Insulation	220° C
Weathershield	WS-4
Wall Bracket	WMB-3
Weight (lbs)	270
Sound (dB)	45

Typical Performance @ 170° C	
Regulation @ 100% PF	3.9%
Regulation @ 80% PF	5.0%
Impedance	5.0%
No Load Losses (W)	85
Full Load Losses (W)	1,470

AMP Ratings	
Line In (Load) @ 240V	154 A
Line In (Load) @ 480V	77 A
Load (Secondary) @ 120V	308 A
Load (Secondary) @ 240V	154 A

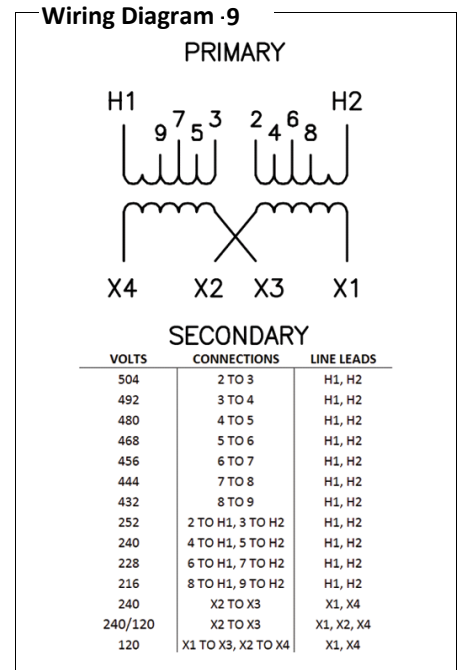

Notes

All units are UL listed and are designed in accordance with applicable NEMA, ANSI and IEEE standards.
 Transformers are dry-type AA, ventilated NEMA 2 enclosure.
 If a weathershield is indicated above this transformer can be converted to a NEMA 3R enclosure.
 Transformers are floor mounted. Wall mounting bracket kit if shown above is optional and is supplied as a separate accessory.
 Paint color is ANSI 61.

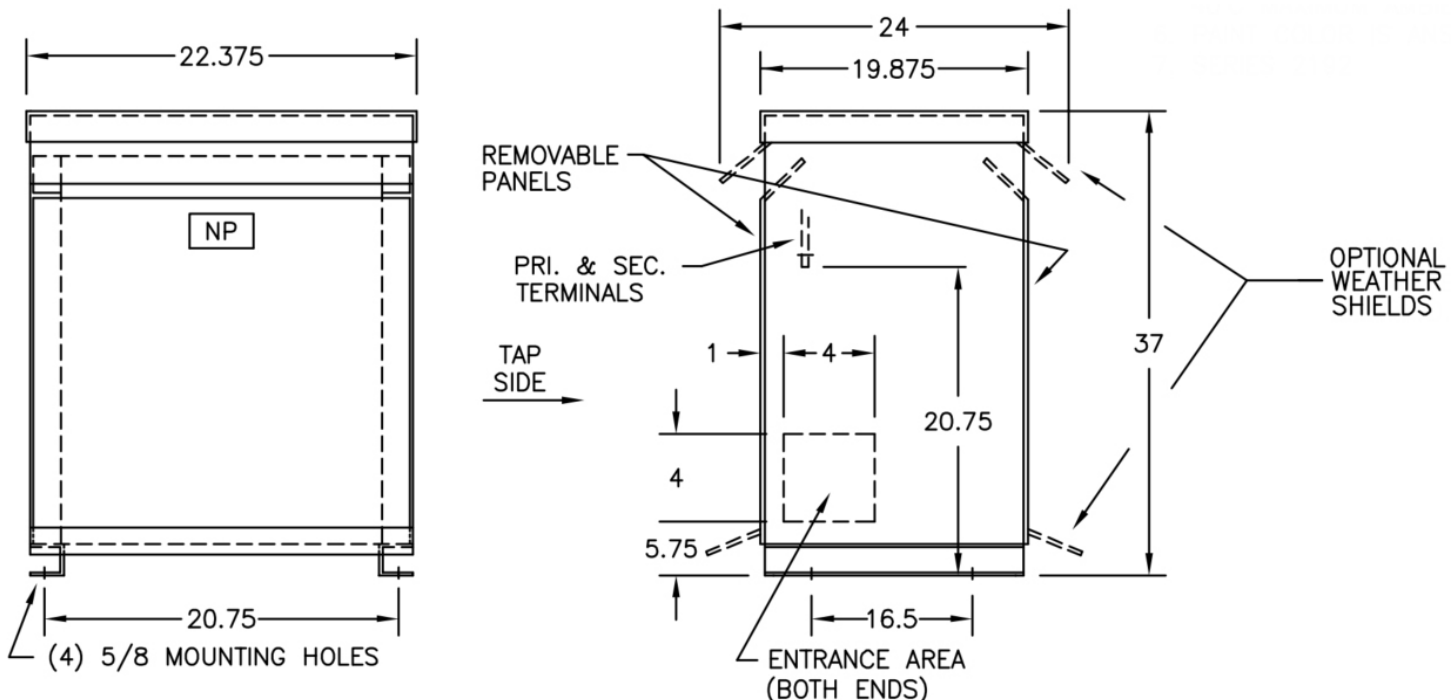

Outline No: 05A1254

Meets 10 CFR 431(DOE 2016) Efficiency
 Dry Type Transformer General Purpose

© 2017 Electro-Mechanical Corporation

For reference only
 Subject to change without notice